

Bluetooth Adapter FSC-BP119B User Guide



1. Introduction

FSC-BP119B is a Bluetooth 5.0 adapter equipped with USB 2.0 interface, supporting multiple audio protocols (such as HFP/AVRCP/A2DP), file transfer protocol (FTP), and multiple data transfer protocols (SPP/GATT/HID).

FSC-BP119B does not need to install drivers under Win7/8/10 system. However, if the driver is not installed, it can only transmit file data, not audio; If you need to transmit audio data, please install the corresponding driver, or contact Feasycom for more details.



2. Main Features

- Support Bluetooth 5.0, compatible with Bluetooth 4.2/4.0/3.0/2.1/2.0
- Windows 7/8/10 system without driver installation for file data transfer
- Supports data and audio transfer after installing the driver under Win7/8/10 system
- Supports HFP/AVRCP/A2DP/FTP/GATT/SPP/HID profiles
- Can be used with Bluetooth speakers/Bluetooth headset/Bluetooth keyboard/Bluetooth mouse/mobile phone/tablet and other devices
- Equipped with whip antenna, the transmission distance can reach up to 20M

3. Product Specifications

Item	Description
Chipset	RTL8761BUV
Bluetooth Version	BT 5.0
Working Frequency	2.4 GHz
Transmission Rate	3 Mbps
Transmit Distance	Up to 20M
Antenna	Whip antenna
Power Supply	USB
Interface	USB2.0
Color	Black
Profiles	HFP/AVRCP/A2DP/FTP/GATT/SPP/HID
System compatibility	Support Win7/8/10, Not support macOS

4. Packing List

- FSC-BP119 x1
- User Guide x1
- Warranty Card x1

5. Product Connection Diagram

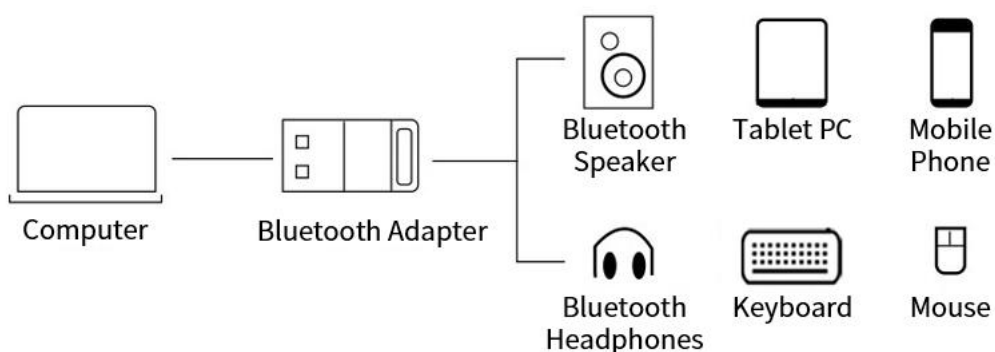

6. Driver Installation

6.1 Example: Install the driver using the Win10 system, right-click "Computer", open Management, click "Computer Management", and then click "Bluetooth" (this is the Bluetooth that comes with the computer)

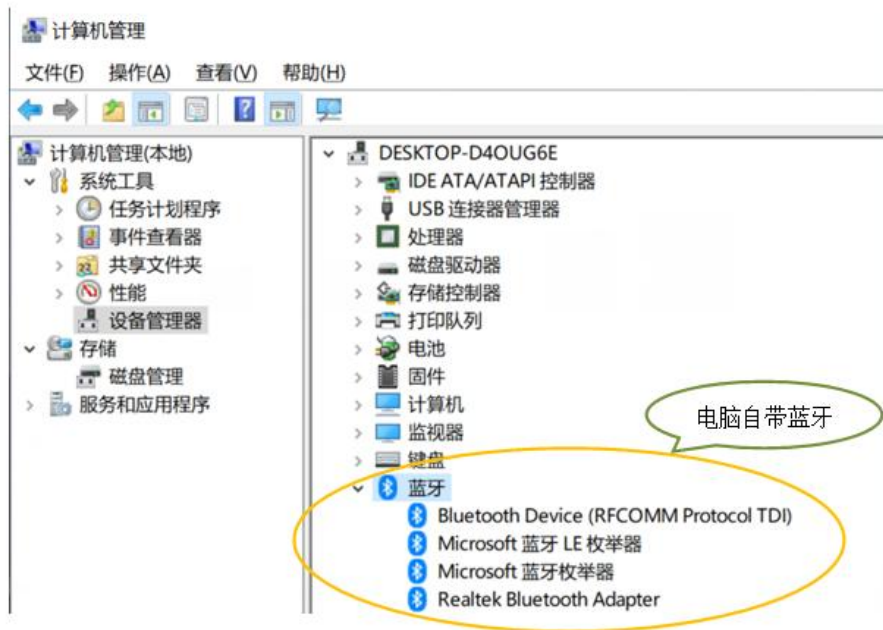

6.2 Disable the Bluetooth that comes with the computer, as shown below:

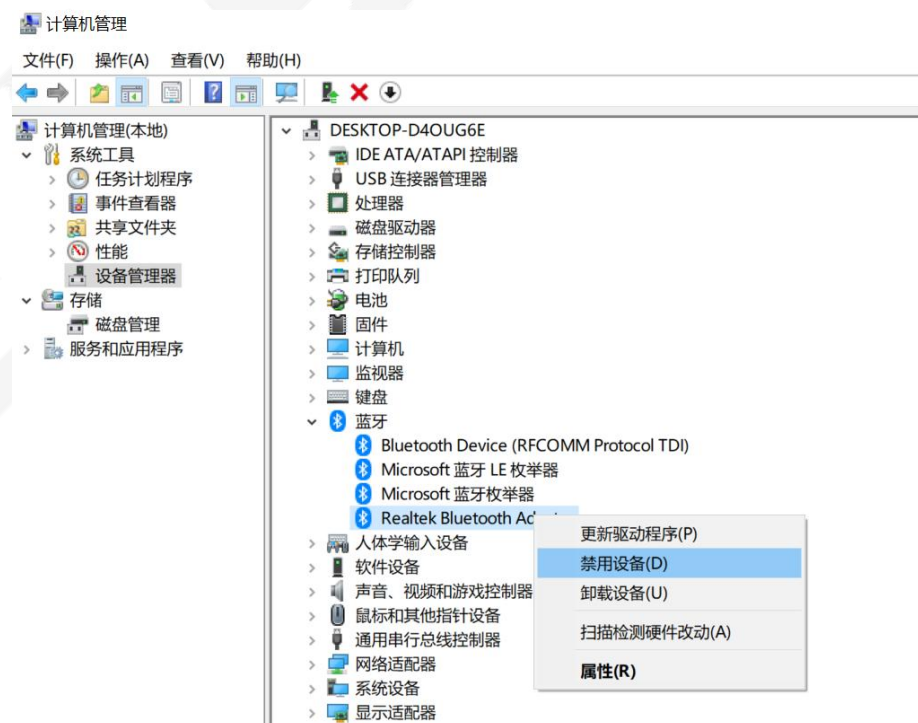

6.3 Plug the Bluetooth adapter into the computer USB port, and then "Realtek Bluetooth Adapter" will appear in the Computer Management, as shown below:

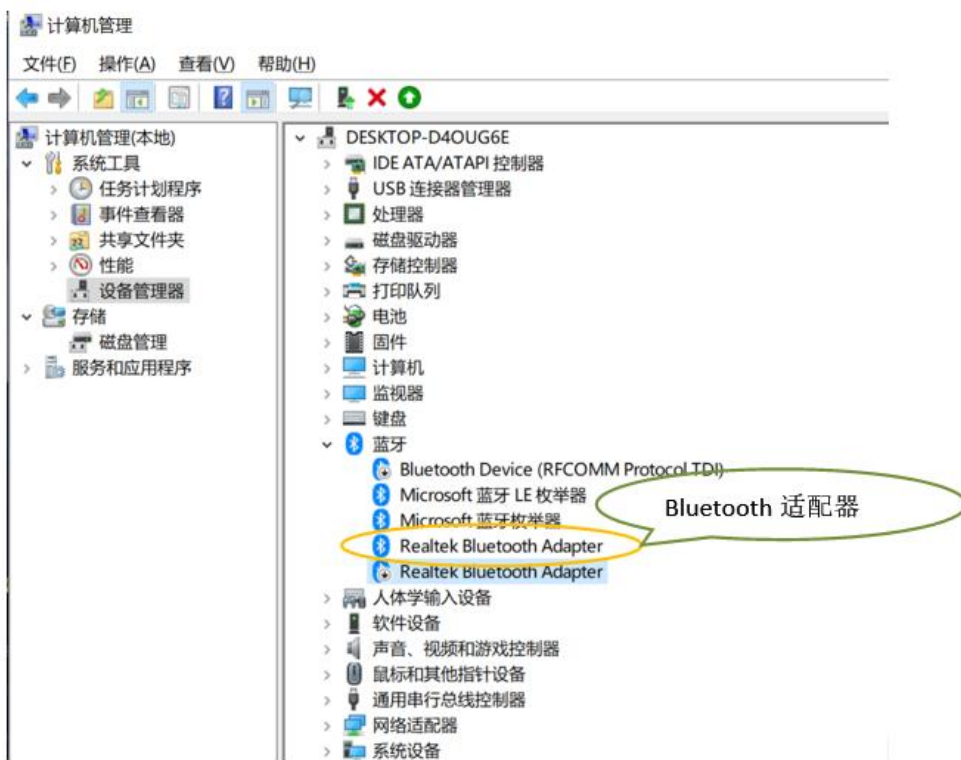

6.4 Right-click "Realtek Bluetooth Adapter", and then click "Update the Driver (P)", as shown below:

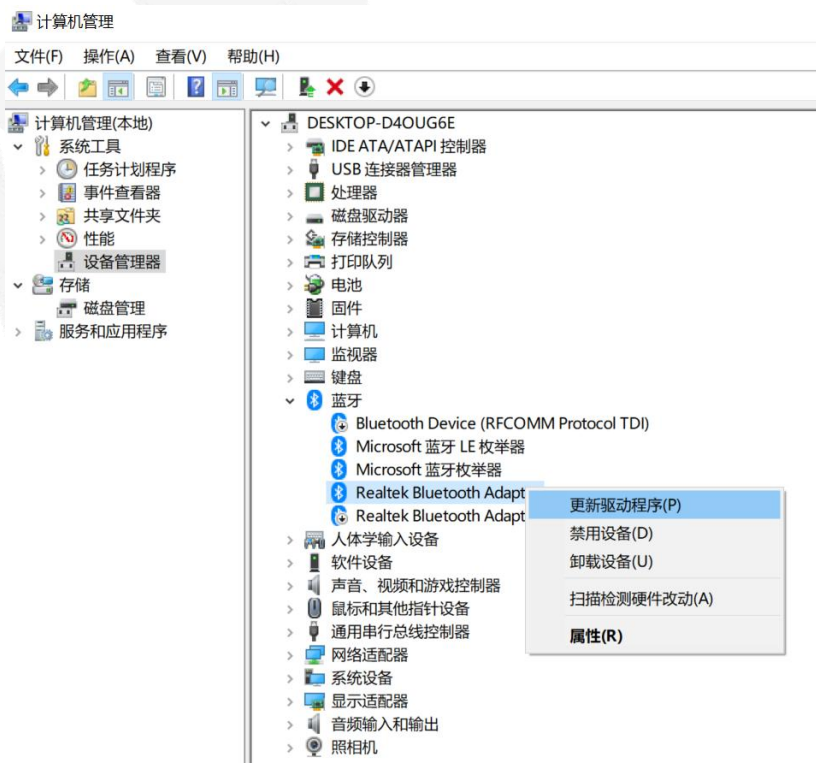

6.5 Click "Browse my computer for driver software (R)", as shown below:

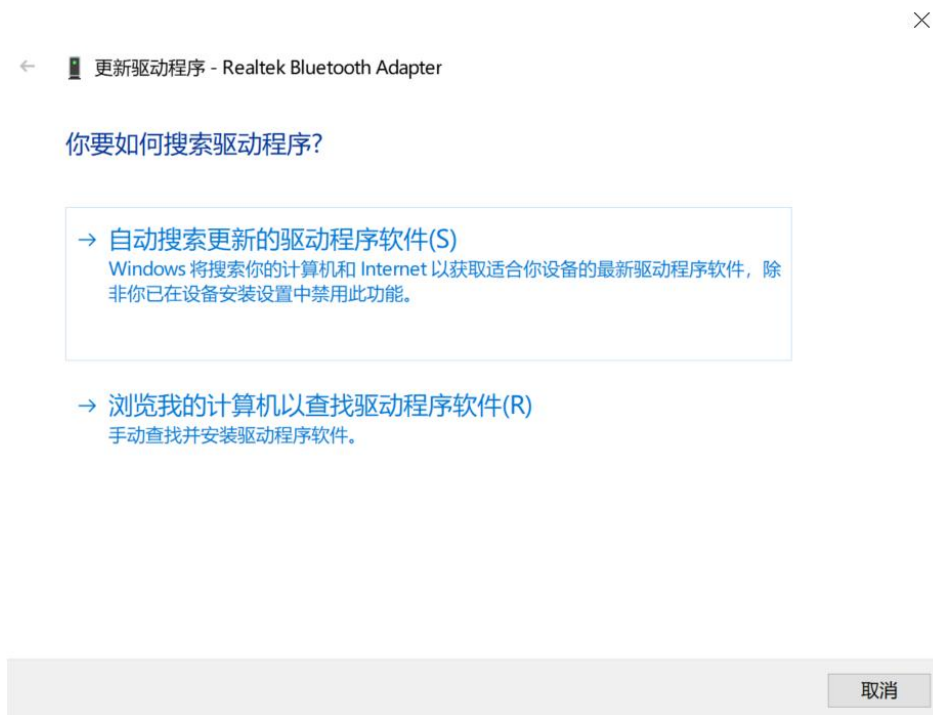

6.6 Click "Browse (R)", and select the path for storing the driver and the driver program corresponding to the installation computer.

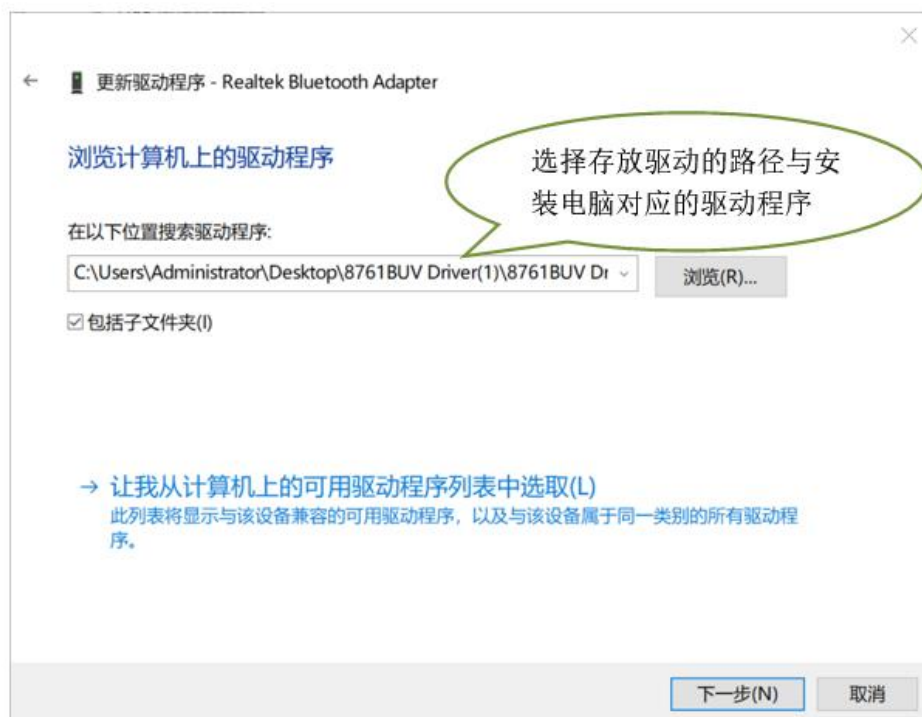

6.7 Updating the driver, as shown below:



6.8 The driver is updated successfully, as shown below:

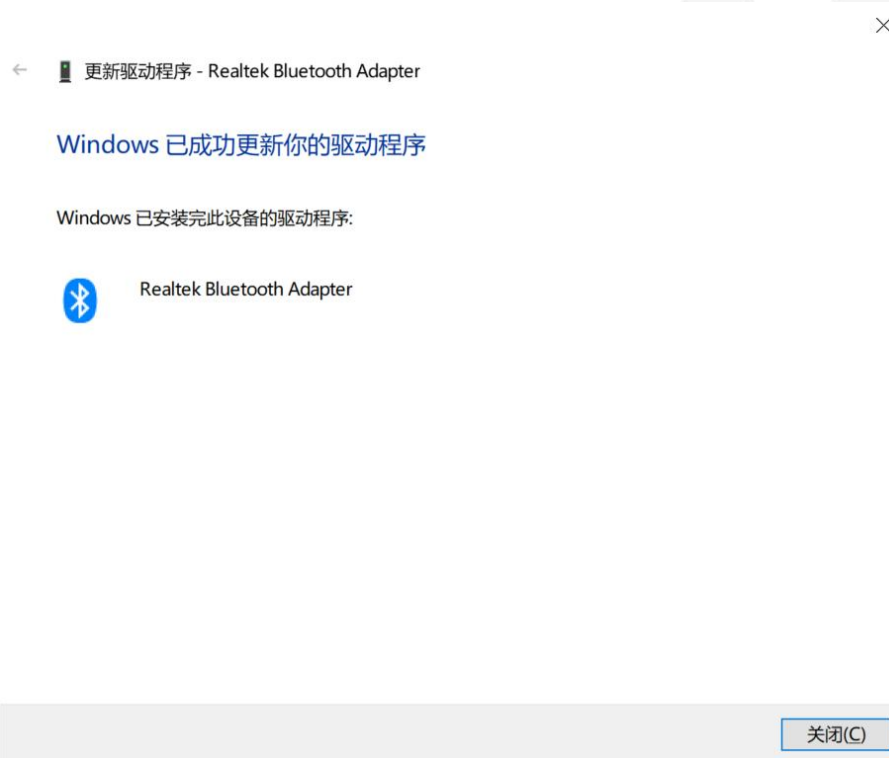

7. Function Description

7.1 This Bluetooth adapter can be used with Bluetooth speaker, Bluetooth headset, Bluetooth keyboard, Bluetooth mouse and other devices. Here, we will introduce the example of connecting a Bluetooth speaker to listen to music and how to use it. The usual steps are: search, connect, set up, use, etc.

7.2 Right-click the "Bluetooth" icon of the computer, and then click "Add Bluetooth Device", as shown below:



7.3 Open the "Bluetooth and other devices" interface, as shown below:

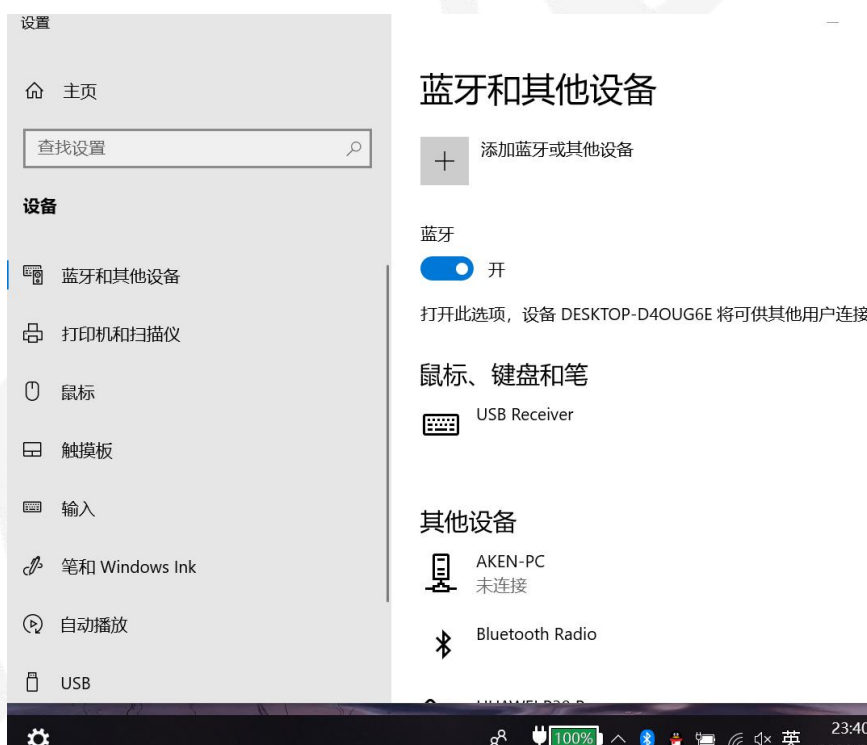

7.4 Click "Add Bluetooth or other device" to enter the "Add device" interface, as shown below:



7.5 Click "Bluetooth" to enter the interface of searching for Bluetooth devices, as shown below:

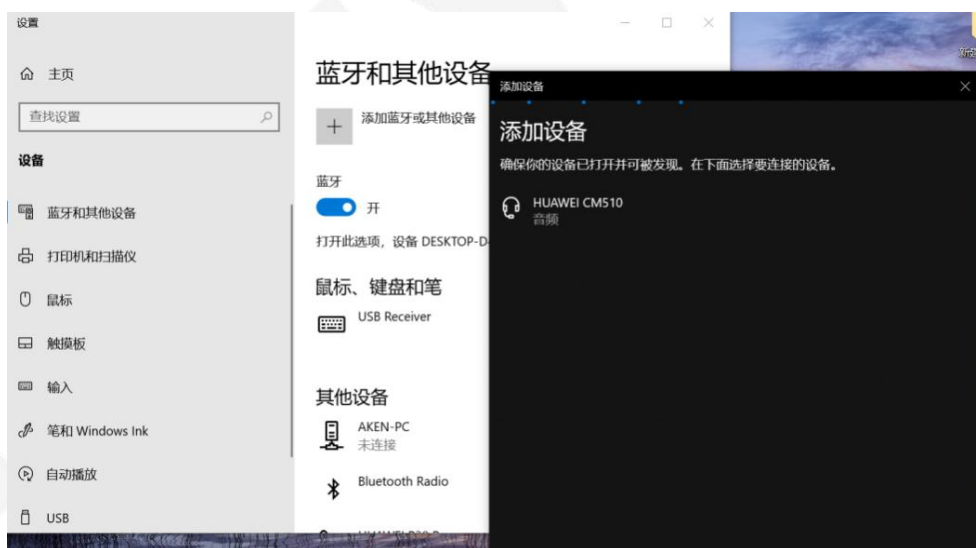

7.6 Double-click the device to be connected with the mouse. For example, double-click the "HUAWEI CM510" device to enter the connection interface, as shown below:

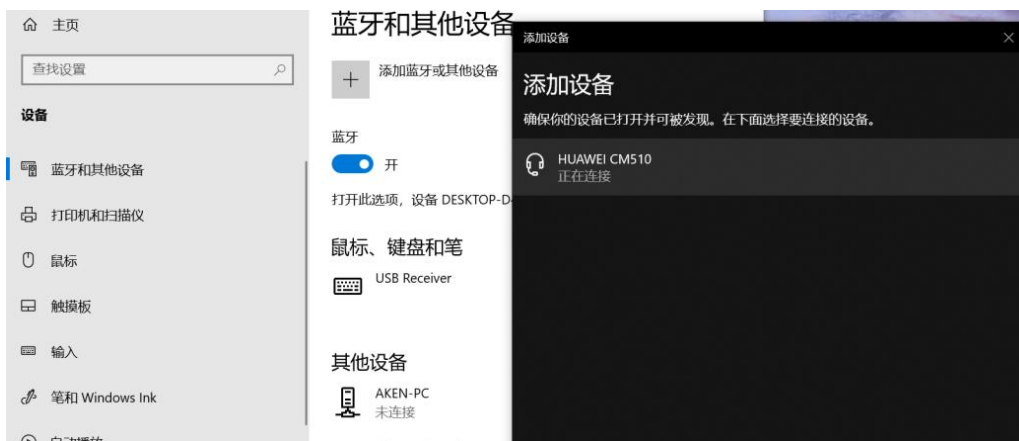

7.7 The "HUAWEI CM510" device is successfully connected, as shown below:

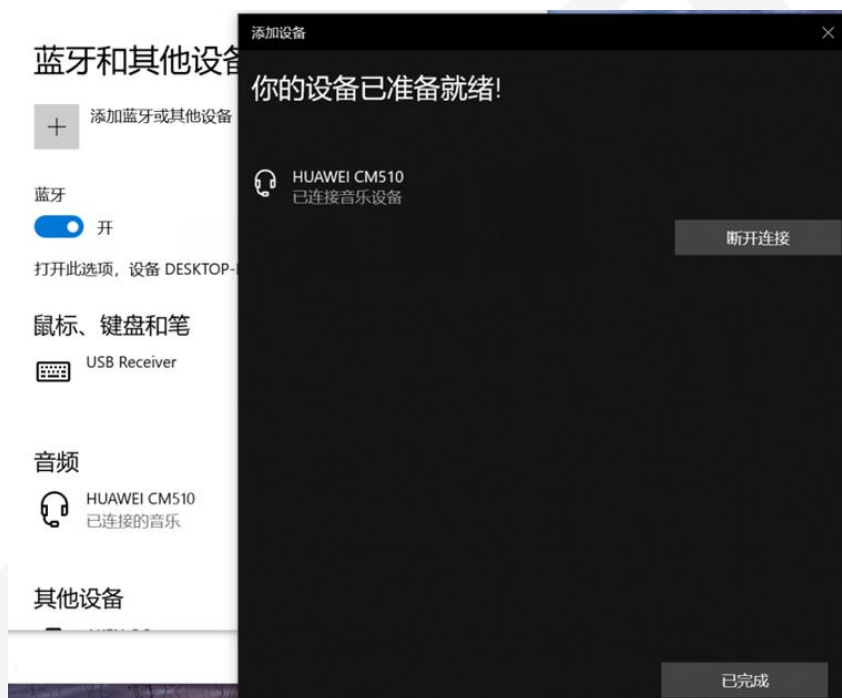

7.8 Right-click and open the computer sound settings "🔊", as shown below:



7.9 Sound input & output settings, as shown below: After setting, any sound from the computer will be played and output from the "HUAWEI CM510" device



8. Dimensions

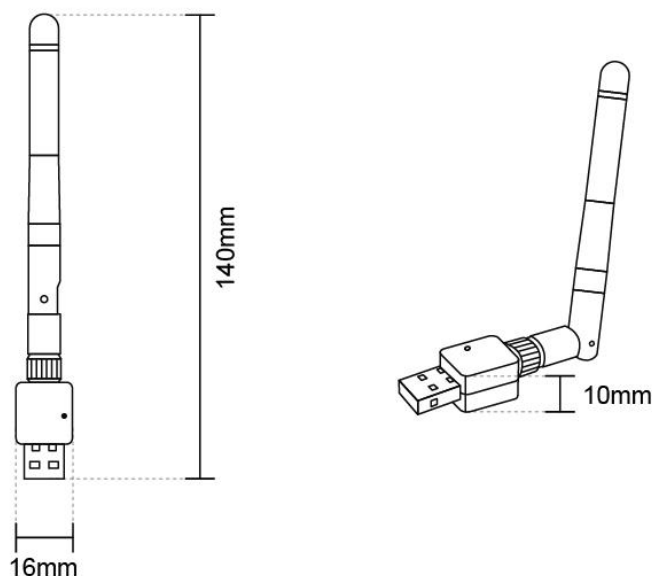

9. Declaration

The contents of this datasheet are subject to change without prior notice for further improvement. Feasycom team reserves all the rights for the final explanation.

iBeacon is a trademark of Apple Inc., Eddystone is a trademark of Google Inc.

Please contact Feasycom sales team or visit <https://www.feasycom.com/> to get more related information if needed.

10. Contact Information

Shenzhen Feasycom Technology Co.,LTD

Address: Rm 508, Building A, Fenghuang Zhigu, No.50, Tiezai Road, Xixiang, Baoan District, Shenzhen, 518102, China

Telephone: 86-755-23062695

Support: support@feasycom.com

Sales Service: sales@feasycom.com

Revision History

Version	Changes	Author
1.0	Initial Release	Devin
1.1	Update description Update product parameters	Jerry