

## FSC-BT825

### 4.2 Dual Mode Bluetooth Module Data Sheet

Document Type: FSC-BT825  
Document Version: V1.4  
Release Date: Jun 21, 2023

### Contact Us

Shenzhen Feasycom Co.,LTD

Email: [sales@feasycom.com](mailto:sales@feasycom.com)

Address: Rm 508, Building A, Fenghuang Zhigu, No.50, Tiezai Road, Xixiang, Baoan District,  
Shenzhen, 518102, China

Tel: 86-755-27924639, 86-755-23062695

## Release Record

Version Number	Release Date	Comments
Revision 1.0	2016-06-24	First Release
Revision 1.1	2019-06-21	1, Upgrade Bluetooth version to BT4.2 2, Modify the description of the error
Revision 1.2	2019-12-11	Add $\pi$ -type matching circuit to optimize antenna performance.
Revision 1.3	2020-05-13	Serial port description information update
Revision 1.4	2023-06-21	<b>Add Description:</b> When the Flow-control of firmw are is off, UART_CTS pin need to be connected to low level, and it can not be in a floating state.

Shenzhen Feasycom Co., LTD

## 1. INTRODUCTION

FSC-BT825 is a fully integrated Bluetooth module that complies with Bluetooth 4.2 dual mode protocols (BR/EDR and LE). It supports SPP, HID, GATT, ATT, and other profiles. It integrates Baseband controller and RF antenna in a small package, so the designers can have better flexibilities for the product shapes.

FSC-BT825 can be communicated by UART port. With Feasycom's Bluetooth stack, Customers can easily transplant to their software. Please refer to Feasycom stack design guide.

### 1.1 Block Diagram

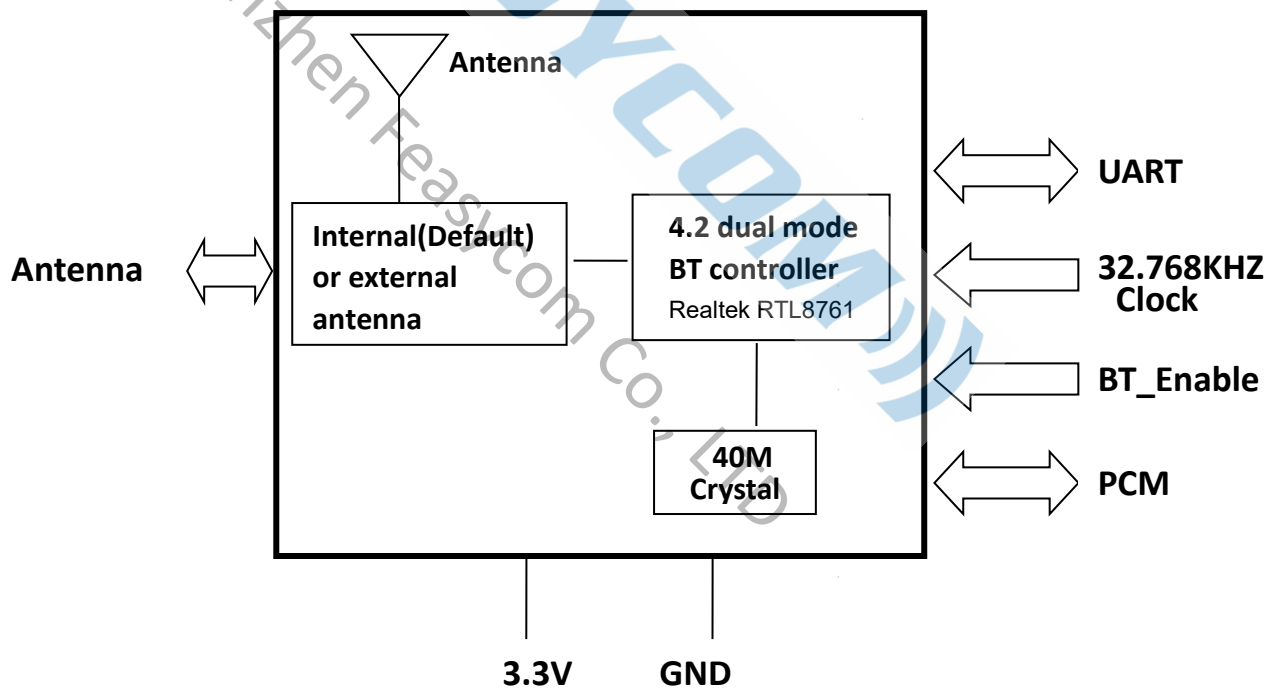


Figure 1

## 1.2 Feature

- ◆ Fully qualified Bluetooth 4.2/4.0/3.0/2.1/2.0/1.2/1.1
- ◆ Postage stamp sized form factor
- ◆ Low power
- ◆ Class 1.5 support(high output power)
- ◆ The default UART Baud rate is 115.2Kbps and can support from 1200bps up to 921.6Kbps
- ◆ UART, PCM hardware interfaces
- ◆ Bluetooth stack profiles support: SPP, HID, GATT, ATT, GAP
- ◆ Support Apple MFi (iAP2), iBeacon

## 1.3 Application

- ◆ Smart Watch and Bluetooth Bracelet
- ◆ Health & Medical devices
- ◆ Wireless POS
- ◆ Measurement and monitoring systems
- ◆ Industrial sensors and controls
- ◆ Asset tacking

## 1.4 Module picture as below showing

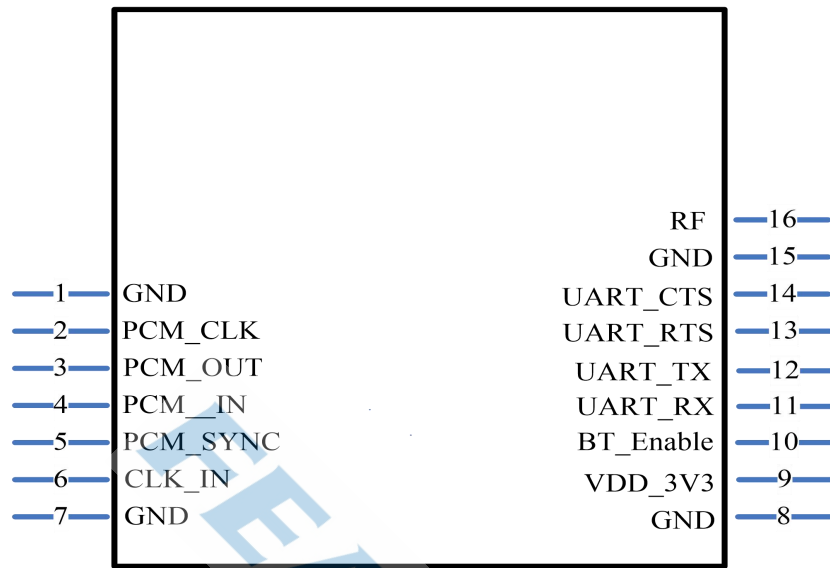


## 2. GENERAL SPECIFICATION

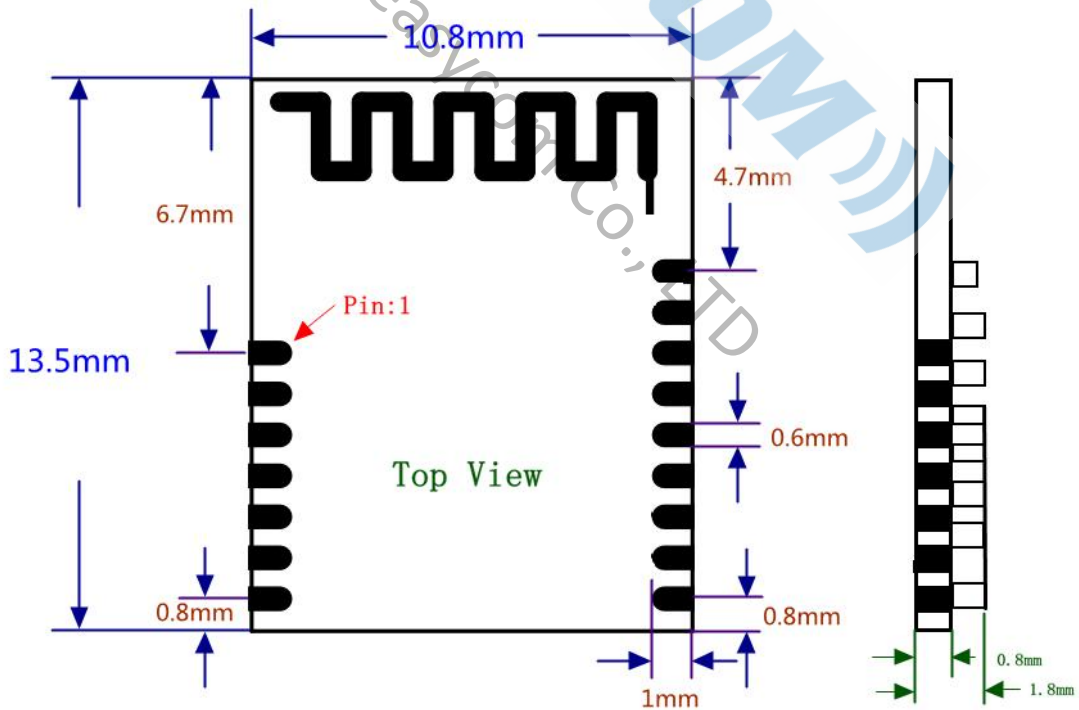
General Specification	
Chip Set	RTL8761
Product ID	FSC-BT825
Dimension	10.8mm(W) x 13.5mm(L) x 1.8mm(H)
Bluetooth Specification	Bluetooth V4.2 (Dual Mode)
Power Supply	3.3 Volt DC
Output Power	5.5 dBm (Class 1.5)
Sensitivity	-82dBm@0.1%BER
Frequency Band	2.402GHz -2.480GHz ISM band
Modulation	GFSK, $\pi/4$ -DQPSK, 8-DPSK
Baseband Crystal OSC	40MHz
Hopping & channels	1600hops/sec, 1MHz channel space,79 Channels(BT 4.2 to 2MHz channel space)
RF Input Impedance	50 ohms
Antenna	Internal (Default) External (Option)
Interface	UART, PCM
Profile	SPP, HID, GATT, ATT, GAP
Advanced Feature	MFi, Airsync, iBeacon
Temperature	0°C to +70 °C
Humidity	10%~95% Non-Condensing
Environmental	RoHS Compliant

Table 1

**3. PHYSICAL CHARACTERISTIC**



**Figure 2:** FSC-BT825 PIN Diagram



**Figure 3:** Pin Configuration and Package Dimensions (TOP VIEW)

## 4. PIN DEFINITION DESCRIPTIONS

Pin	Pin Name	Pad Type	Description
1	GND	VSS	Power Ground
2	PCM-CLK	Bi-directional	Synchronous data clock(operating votage level: 3.3V)
3	PCM_OUT	CMOS output	Synchronous data output(operating votage level: 3.3V)
4	PCM_IN	CMOS input	Synchronous data input(operating votage level: 3.3V)
5	PCM-SYNC	Bi-directional	Synchronous data sync(operating votage level: 3.3V)
6	CLK_IN	CMOS input	32.768kHz clock in Connect to external clock(optional) NC (default)
7	GND	VSS	Power Ground
8	GND	VSS	Power Ground
9	VDD_3V3	VDD	Power supply voltage 3.3V
10	BT_Enable	CMOS input	Module enable input(active high) <b>Note: VDD_3V3 must be stable before pulling up BT_Enable</b>
11	UART_RX	CMOS input	UART data input
12	UART_TX	CMOS output	UART data output
13	UART_RTS	CMOS output	UART request to send active low
14	UART_CTS	CMOS input	UART clear to send active low <b>Add Description: When the Flow-control of firmware is off, UART_CTS pin need to be connected to low level, and it can not be in a floating state.</b>
15	GND	VSS	Power Ground
16	RF	RF_IN/OUT	Bluetooth 50ohm transmitter output/receiver input NC if using internal antenna(default) Connect to external antenna(optional)

Table 2

## 5. Interface Characteristics

### 5.1 UART Interface

Four signals are used to implement the UART function. When FSC-BT825 is connected to another digital device, UART\_RX and UART\_TX transfer data between the two devices. The

remaining two signals, UART\_CTS and UART\_RTS, can be used to implement RS232 hardware flow control where both are active low indicators.

The interface consists of four-line connection as described in below:

Signal name	Driving source	Description
UART-TX	FSC-BT825 module	Data from FSC-BT825 module
UART-RX	Host	Data from Host
UART-RTS	FSC-BT825 module	Request to send output of FSC-BT825 module
UART-CTS	Host	Clear to send input of FSC-BT825 module

**Table 3**

Default Data Format

Property	Possible Values
Baudrate	115.2 Kbps
Flow Control	None
Data bit length	9bit
Parity	EVEN
Number of Stop Bits	1

**Table 4**

Desired Baud Rate	Actual Baud Rate	Error (%)	Desired Baud Rate	Actual Baud Rate	Error (%)
300	300	0.00%	153600	153061	-0.35%
600	600	0.00%	230400	229167	-0.54%
900	900	0.00%	460800	458333	-0.54%
1200	1200	0.00%	500000	500000	0.00%
1800	1800	0.00%	921600	916667	-0.54%
2400	2400	0.00%	1000000	1000000	0.00%
3600	3601	0.03%	1382400	1375000	-0.54%
4800	4798	-0.04%	1444444	1437500	-0.48%
7200	7198	-0.03%	1500000	1500000	0.00%
9600	9603	0.03%	1843200	1833333	-0.54%
14400	14395	-0.03%	2000000	2000000	0.00%
19200	19182	-0.09%	2100000	2083333	-0.79%
28800	28846	0.16%	2764800	2777778	0.47%
38400	38462	0.16%	3000000	3000000	0.00%
56000	55970	-0.05%	3250000	3250000	0.00%
57600	57692	0.16%	3692300	3703704	0.31%
76800	76531	-0.35%	3750000	3750000	0.00%
115200	115385	0.16%	4000000	4000000	0.00%
128000	127119	-0.69%			

**Table 5. UART Interface Power-On Timing Parameters**



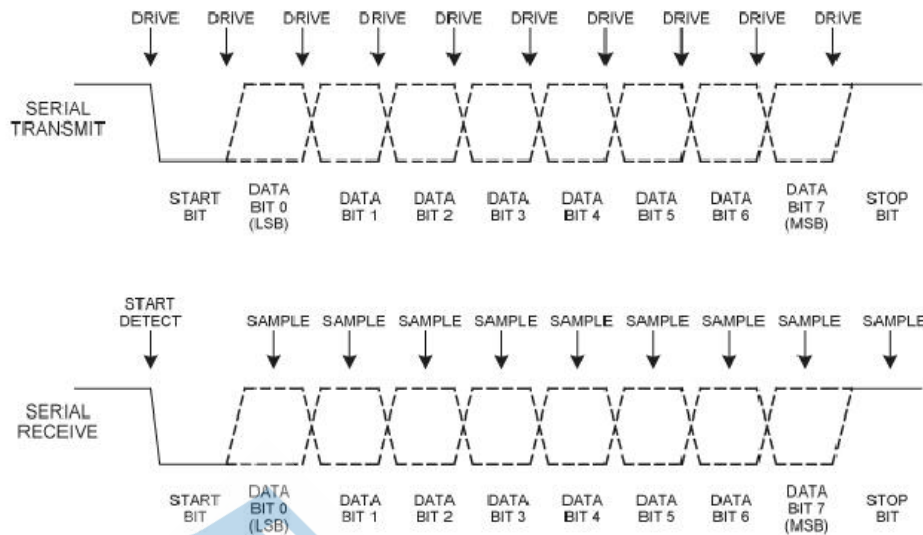


Figure 4: UART Interface Waveform PIN diagram

### 5.1.1 UART Interface Power-On Sequence

The UART interface power-on sequence differs depending on whether or not host flow control is supported.

#### UART Hardware Flow Control Not Supported

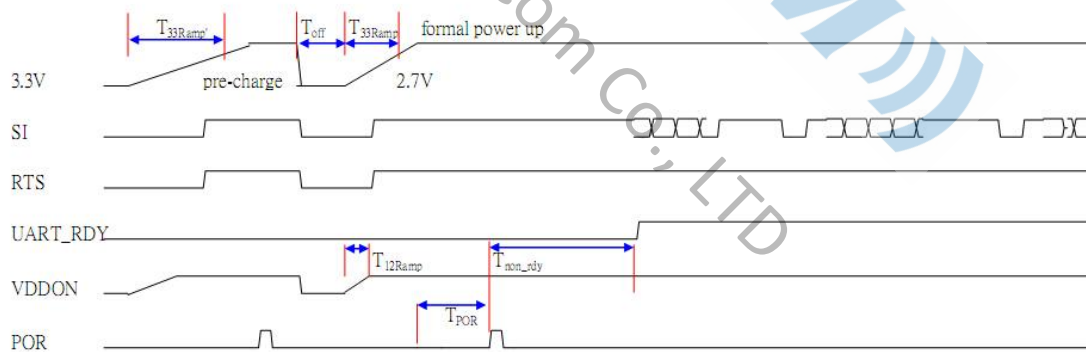
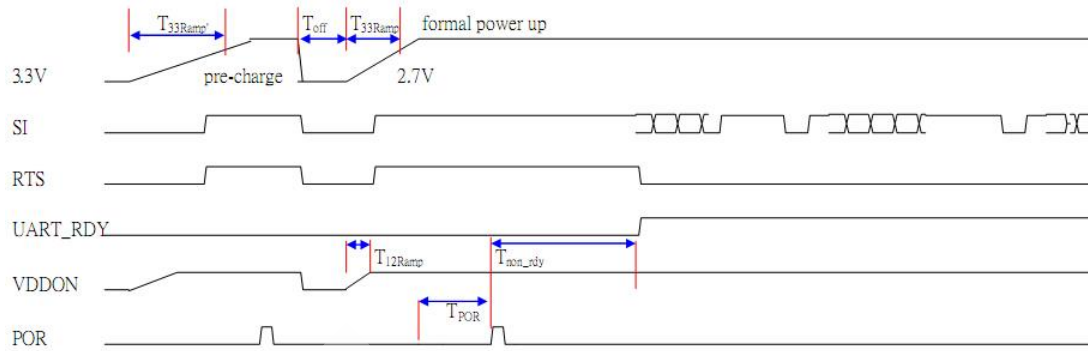


Figure 5: UART Power-On Sequence without Hardware Flow Control

## UART Hardware Flow Control Supported



**Figure 6:** UART Power On Sequence with Hardware Flow Control

Symbol	Description
$T_{33ramp}$	3.3V Power Pre-Charge Ramp Up Duration Before Formal Power Up. We recommend that a 3.3V power-on and then power-off sequence is executed by the host controller before the formal power on sequence. This procedure can eliminate host card detection issues when power ramp up duration is too long, or when a system warm reboot fails.
$T_{off}$	The duration 3.3V is cut off before formal power up.
$T_{33ramp}$	The 3.3V main power ramp up duration.
$T_{12ramp}$	The internal 1.2V ramp up duration.
$T_{POR}$	The duration from when the power-on reset releases and the power management unit executes power on tasks. A power on reset will detect both 3.3V and 1.2V power ramp up after a predetermined duration.
$T_{non\_rdy}$	UART Not Ready Duration. In this state, the FSC-BT825 will not respond to any commands.

**Table 6:** UART Interface Power-On Sequence

In this state, the FSC-BT825 will not respond to any commands. divided into two phases: A 3.3V power pre-charge phase and a formal power-up phase.

During the 3.3V power pre-charge phase, the power ramp up duration is not limited. The 3.3V

power is cut off and is turned on after the Toff period. The ramp up time is specified in the T33ramp duration.

After main 3.3V ramp up and 1.2V ramp up, the power management unit is enabled by the power ready detection circuit. The power management unit enable s the Bluetooth block. The Bluetooth firmware then initializes all circuits, included the UART. In addition to waiting the Tnon\_rdy time, if the host supports UART hardware flow control it can detect RTS signals and follow the formal UART flow control handshake.

	Min	Typical	Max	Unit
T33ramp	-	-	No Limit	ms
Toff	250	500	1000	ms
T33ramp	0.1	0.5	2.5	ms
T12ramp	0.1	0.5	1.5	ms
TPOR	2	2	8	ms
Tnon_rdy	1	2	10	ms

**Table 7:** UART Interface Power On Timing Parameters

## 5.2 PCM CODEC Interface

The FSC-BT825 supports a PCM digital audio interface that is used for transmitting digital audio/voice data to/from the Audio Codec. Features are supported as below:

- Supports Master and Slave mode
- Programmable long/short Frame Sync
- Supports 8-bit A-law/u-law, and 13/16-bit linear PCM formats
- Supports Master and Slave mode
- Supports sign-extension and zero-padding for 8-bit and 13-bit samples
- Supports padding of Audio Gain to 13-bit samples
- PCM Master Clock Output: 64, 128, 256, or 512kHz
- Supports Master and Slave mode
- Supports SCO/ESCO link

## 5.2.1 PCM Format

FrameSync is the synchronizing function used to control the transfer of DAC\_Data and ADC\_Data. A Long FrameSync indicates the start of ADC\_Data at the rising edge of FrameSync, and a Short FrameSync indicates the start of ADC\_Data at the falling edge of FrameSync.

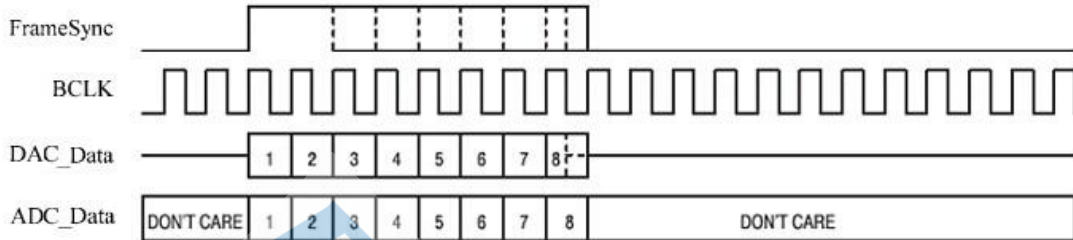


Figure 7. Long FrameSync

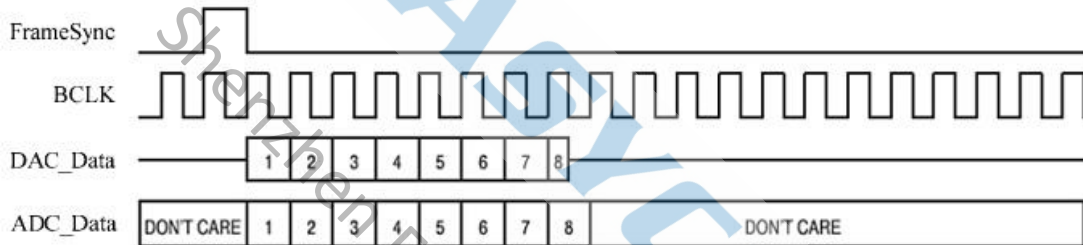


Figure 8. Short FrameSync

## 5.2.2 Sign Extension and Zero Padding for 8-Bit and 13-Bit Samples

◆ For 16-bit linear PCM output, 3 or 8 unused bits may be sign extended/zero padded.

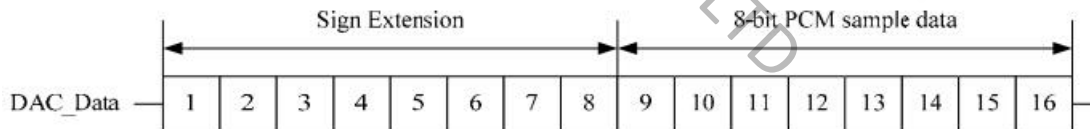


Figure 9. 16-Bit Output Data with 8-Bit PCM Sample Data and Sign Extension

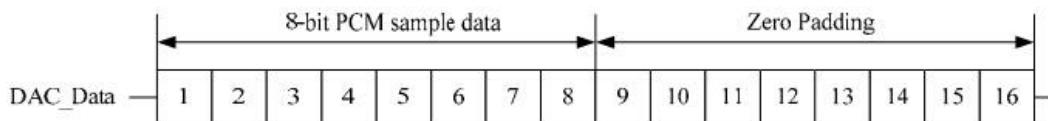
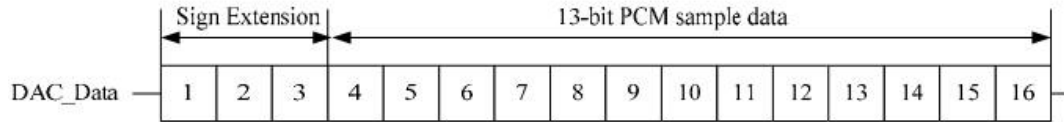
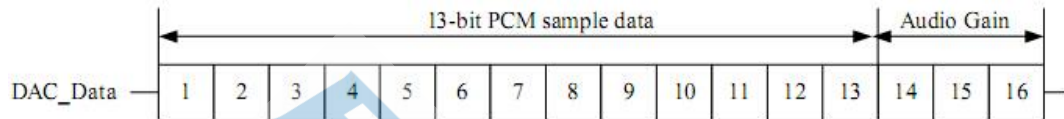


Figure 10 16-Bit Output Data with 8-Bit PCM Sample Data and Zero Padding



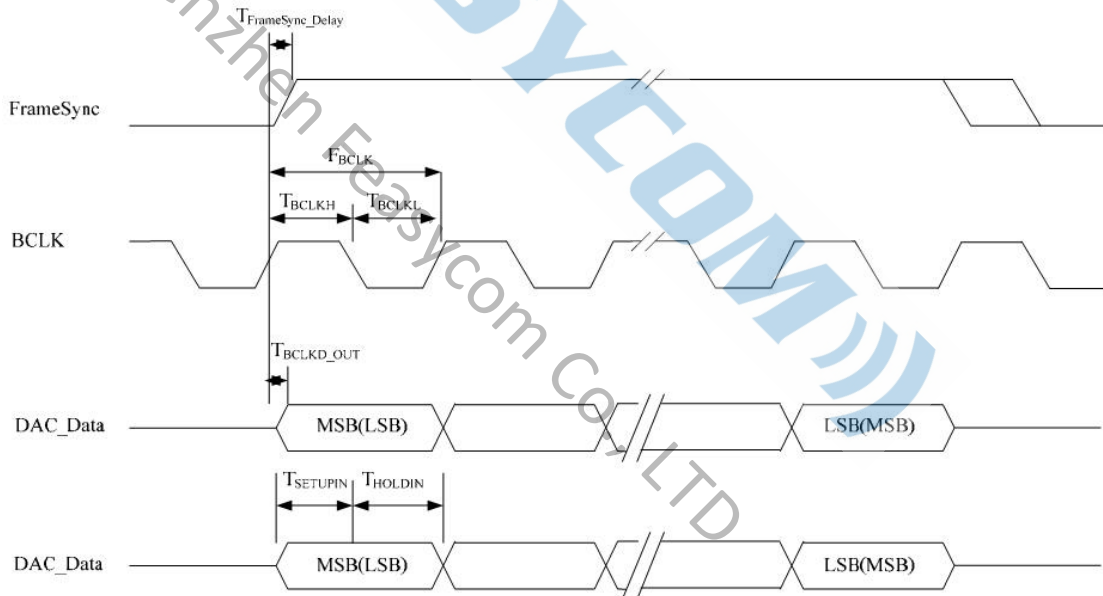
**Figure 11.** 16-Bit Output Data with 13-Bit PCM Sample Data and Sign Extension

◆ For 16-bit linear PCM output, 3-bit programmable audio gain value can be padded to 13-bit sample data.

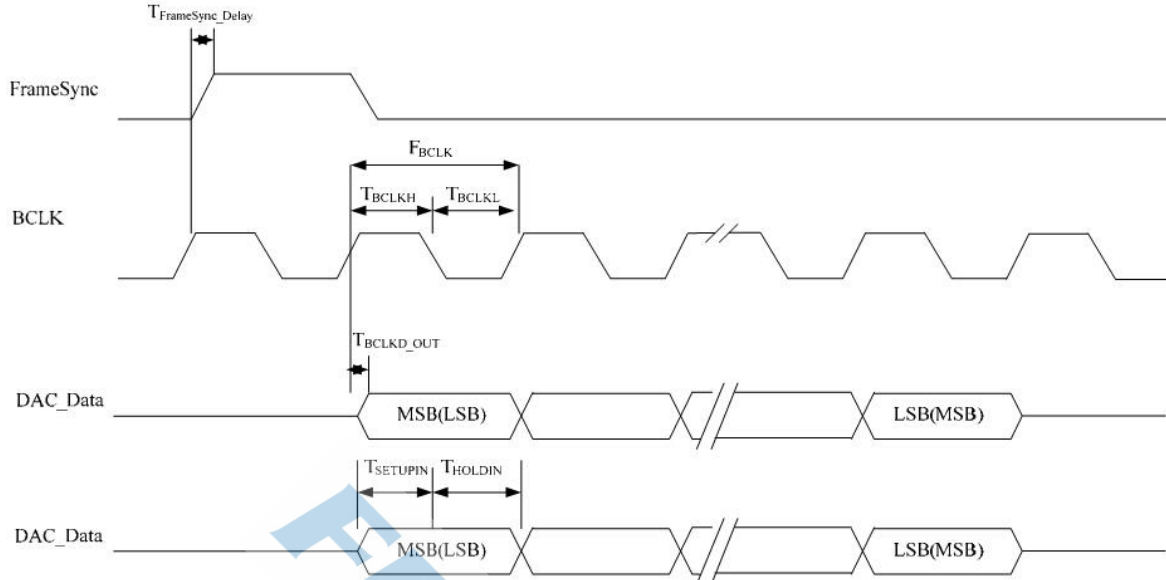


**Figure 12.** 16-Bit Output Data with 13-Bit PCM Sample Data and Audio Gain

### 5.2.3 PCM Interface Timing



**Figure 13:** PCM Interface (Long FrameSync)



**Figure 14:** PCM Interface (Short FrameSync)

Symbol	Description	Min	Typ	Max	Unit
$F_{BCLK}$	Frequency of BCLK (Master)	64	-	512	KHz
$F_{FrameSync}$	Frequency of Frame Sync (Master)	-	8	8	KHz
$F_{BCLK}$	Frequency of BCLK (Slave)	64	-	512	KHz
$F_{FrameSync}$	Frequency of Frame Sync (Slave)	-	8	-	KHz
D	Data Size	8	8	16	bits
N	Number of Slots Per Frame	1	1	1	Slots

**Table 8:** PCM Interface Clock Specifications

Symbol	Description	Min	Typ	Max	Unit
$T_{BCLKH}$	High Period of BCLK	980	-	-	ns
$T_{BCLKL}$	Low Period of BCLK	970	-	-	ns
$F_{FrameSync\_Delay}$	Delay Time from BCLK High to Frame Sync High	-	-	75	ns

T <sub>BCLKD_OUT</sub>	Delay Time from BCLK High to Valid DAC_Data	-	-	125	ns
T <sub>SETUPIN</sub>	Set-up Time for ADC_Data Valid to BCLK Low	10	-	-	ns
T <sub>HOLDIN</sub>	Hold Time for BCLK Low to ADC_Data Invalid	125	-	-	ns

**Table 9:** PCM Interface Timing

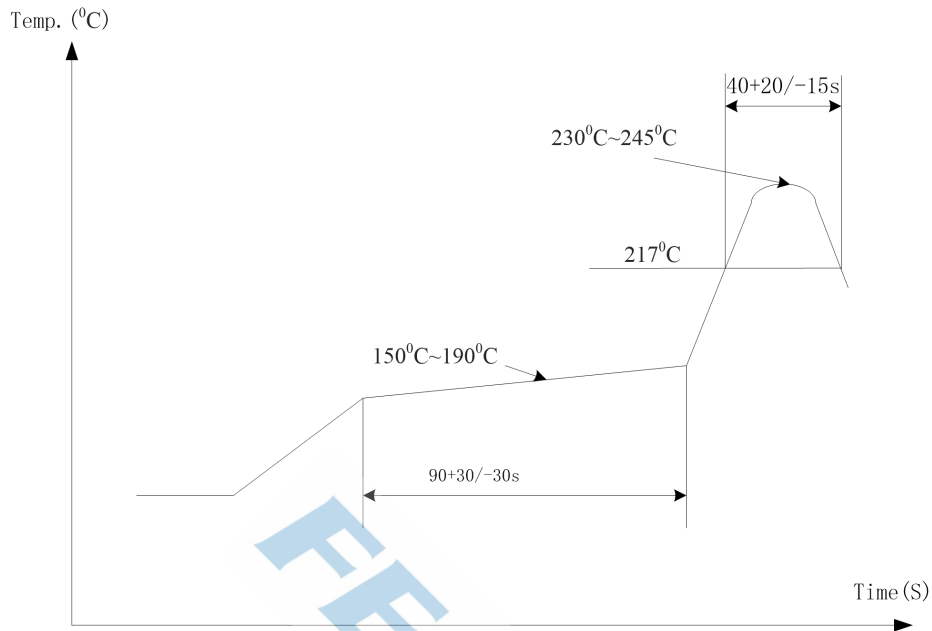
### 5.2.4 PCM Interface Signal Levels

The PCM signal level ranges from 1.8V to 3.3V. The host provides the power source with the targeted power level to the FSC-BT825 PCM interface.

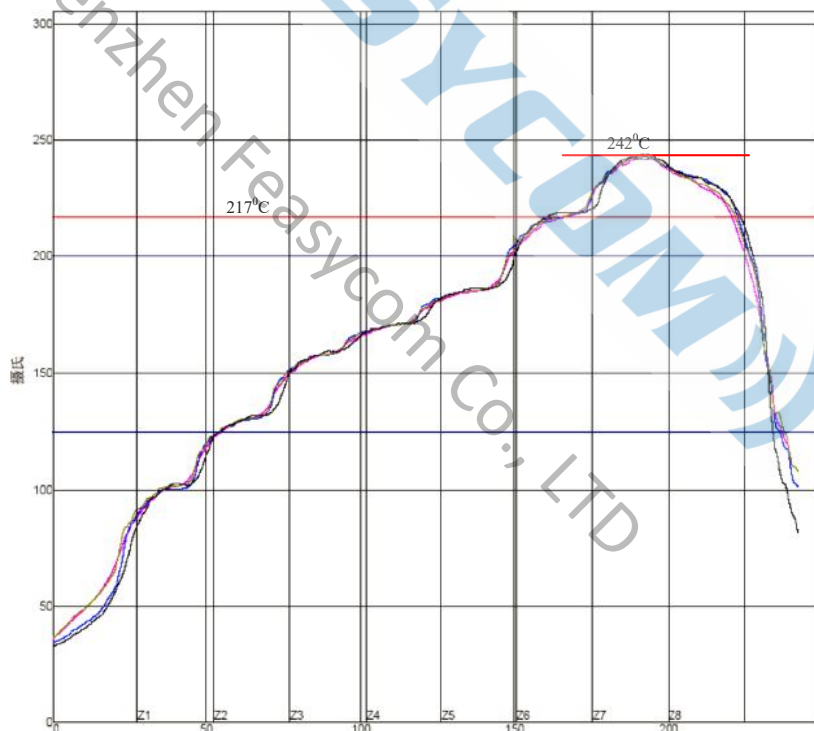
## 6. RECOMMENDED TEMPERATURE REFLOW PROFILE

The re-flow profiles are illustrated in Figure 14 and Figure 15 below.

- Follow: IPC/JEDEC J-STD-020 C
- Condition:
  - Average ramp-up rate(217°C to peak):1~2°C/sec max.
  - Preheat:150~200C,60~180 seconds
  - Temperature maintained above 217°C:60~150 seconds
  - Time within 5°C of actual peak temperature:20~40 sec.
  - Peak temperature:250+0/-5°C or 260+0/-5°C
  - Ramp-down rate:3°C/sec.max.
  - Time 25°C to peak temperature:8 minutes max
  - Cycloe interval: 5 minus



**Figure 15** Typical Lead-free Re-flow Solder Profile



**Figure16** Typical Lead-free Re-flow

The soldering profile depends on various parameters according to the use of different solder and material. The data here is given only for guidance on solder re-flow.

FSC-BT825 will withstand up to two re-flows to a maximum temperature of 245°C.



## 7. Reliability and Environmental Specification

### 7.1 Temperature test

Put the module in demo board which uses exit power supply, power on the module and connect to mobile. Then put the demo in the  $-20^{\circ}\text{C}$  space for 1 hour and then move to  $+70^{\circ}\text{C}$  space within 1 minute, after 1 hour move back to  $-20^{\circ}\text{C}$  space within 1 minute. This is 1 cycle. The cycles are 32 times and the units have to pass the testing.

### 7.2 Vibration Test

The module is being tested without package. The displacement requests 1.5mm and sample is vibrated in three directions(X,Y,Z).Vibration frequency set as 0.5G , a sweep rate of 0.1 octave/min from 5Hz to 100Hz last for 90 minutes each direction. Vibration frequency set as 1.5G, a sweep rate of 0.25 octave/min from 100Hz to 500Hz last for 20 minutes each direction.

### 7.3 Desquamation test

Use clamp to fix the module, measure the pull of the component in the module, make sure the module`s soldering is good.

### 7.4 Drop test

Free fall the module (condition built in a wrapper which can defend ESD) from 150cm height to cement ground, each side twice, total twelve times. The appearance will not be damaged and all functions OK.

### 7.5 Packaging information

After unpacking, the module should be stored in environment as follows:

Temperature:  $25^{\circ}\text{C} \pm 2^{\circ}\text{C}$

Humidity: <60%

No acidity, sulfur or chlorine environment

The module must be used in four days after unpacking.

## 8. Layout and Soldering Considerations

### 8.1 Soldering Recommendations

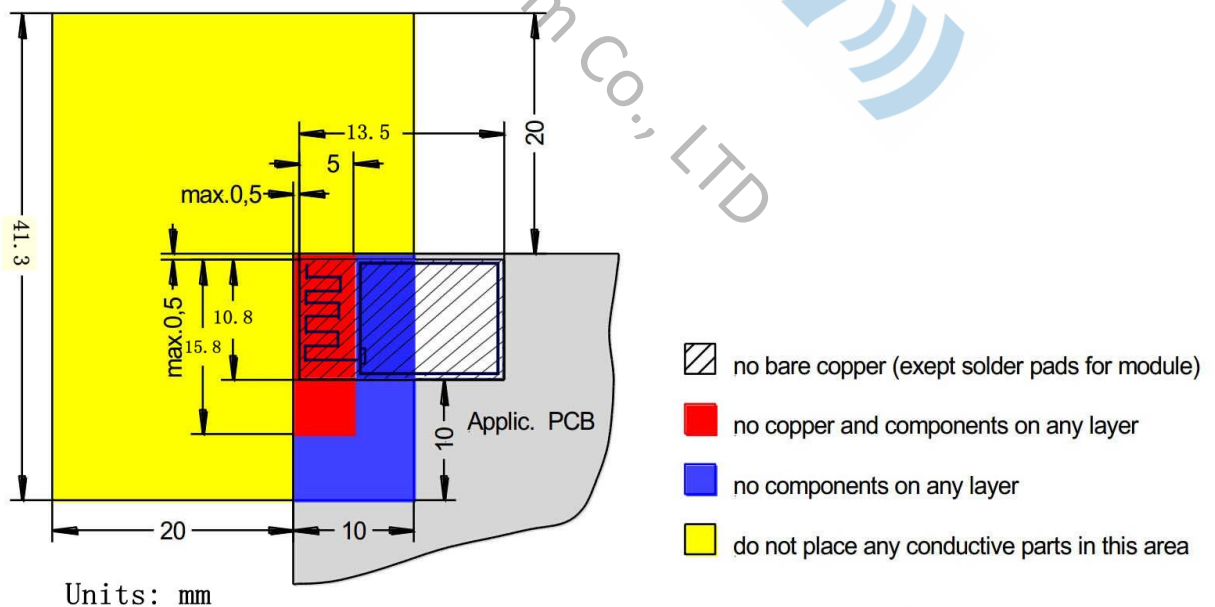
FSC-BT825 is compatible with industrial standard reflow profile for Pb-free solders. The reflow profile used is dependent on the thermal mass of the entire populated PCB, heat transfer efficiency of the oven and particular type of solder paste used. Consult the datasheet of particular solder paste for profile configurations.

Feasycom will give following recommendations for soldering the module to ensure reliable solder joint and operation of the module after soldering. Since the profile used is process and layout dependent, the optimum profile should be studied case by case. Thus following recommendation should be taken as a starting point guide.

### 8.2 Layout Guidelines

It is strongly recommended to use good layout practices to ensure proper operation of the module. Placing copper or any metal near antenna deteriorates its operation by having effect on the matching properties. Metal shield around the antenna will prevent the radiation and thus metal case should not be used with the module. Use grounding vias separated max 3 mm apart at the edge of grounding areas to prevent RF penetrating inside the PCB and causing an unintentional resonator. Use GND vias all around the PCB edges.

The mother board should have no bare conductors or vias in this restricted area, because it is not covered by stop mask print. Also no copper (planes, traces or vias) are allowed in this area, because of mismatching the on-board antenna.



provide solid ground plane(s) as large as possible around area

Figure 17: FSC-BT825 Restricted Area

Following recommendations helps to avoid EMC problems arising in the design. Note that each design is unique and the following list do not consider all basic design rules such as avoiding capacitive coupling between signal lines. Following list is aimed to avoid EMC problems caused by RF part of the module. Use good consideration to avoid problems arising from digital signals in the design.

Ensure that signal lines have return paths as short as possible. For example if a signal goes to an inner layer through a via, always use ground vias around it. Locate them tightly and symmetrically around the signal vias. Routing of any sensitive signals should be done in the inner layers of the PCB. Sensitive traces should have a ground area above and under the line. If this is not possible, make sure that the return path is short by other means (for example using a ground line next to the signal line).

## 9. Application Schematic

