



FSC-DB006 6 PIN Bluetooth Dev Board User Guide

Type: Dev Board User Guide

Version: V1.1

Date: 2019.08.29

Shenzhen Feasycom Technology Co., Ltd

Shenzhen Feasycom Technology Co.,Ltd.

Telephone: 86-755-27924639

www.feasycom.com

FSC-DB006 DISCOVERY LITE Front Image

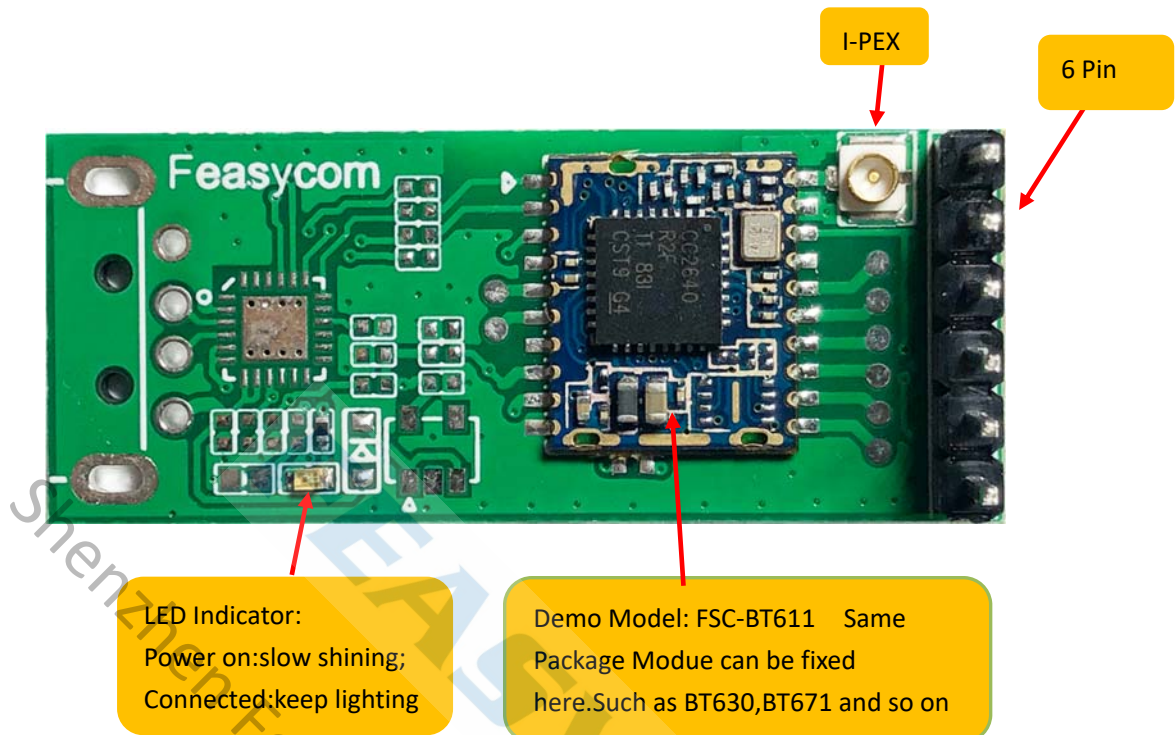

FSC-DB006 DISCOVERY LITE Back Image



Pin description:

STATUS is the status indicator pin, the Bluetooth connection is high, and the connection is low.
TX is the UART data output.
RX is the UART data input.
GND is the power ground.
3.3V is the power supply pin.
KEY is the mode switching pin, the high level is the command mode, and the low level is the transparent transmission mode

FSC-DB006 dimension , location map and schematic

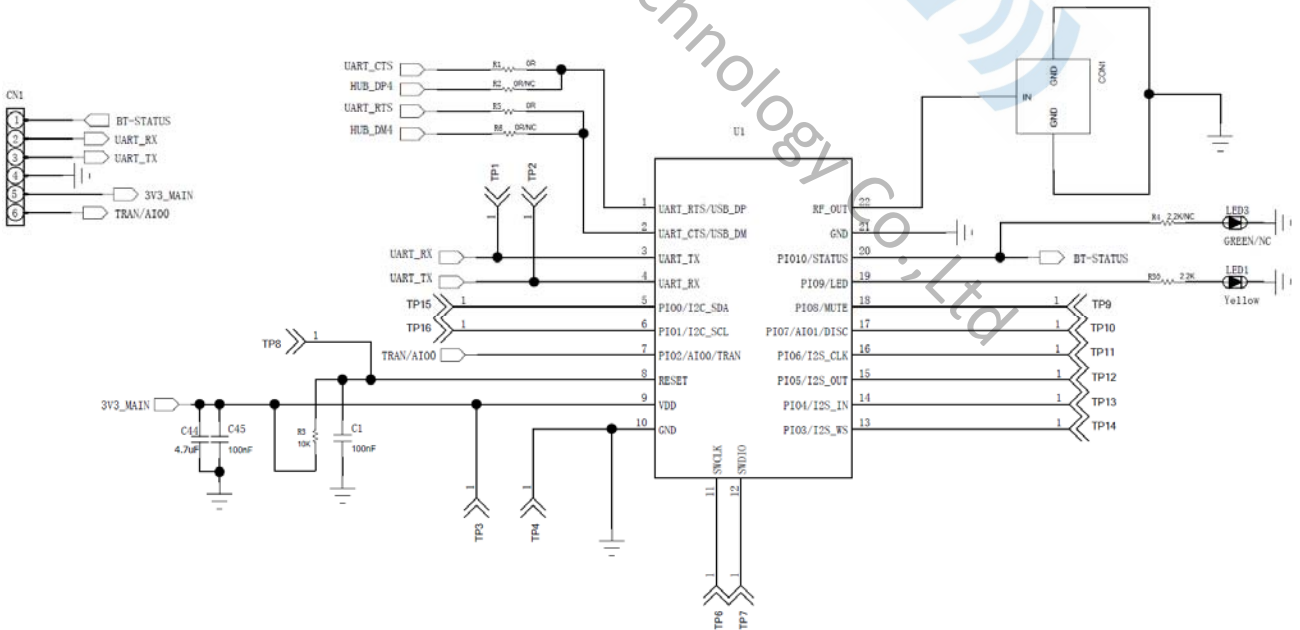
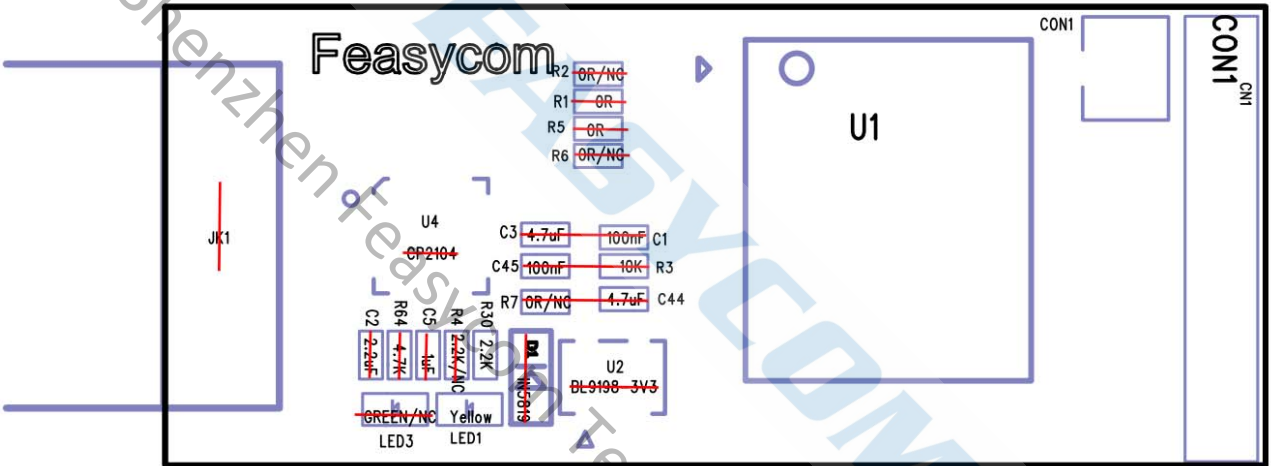
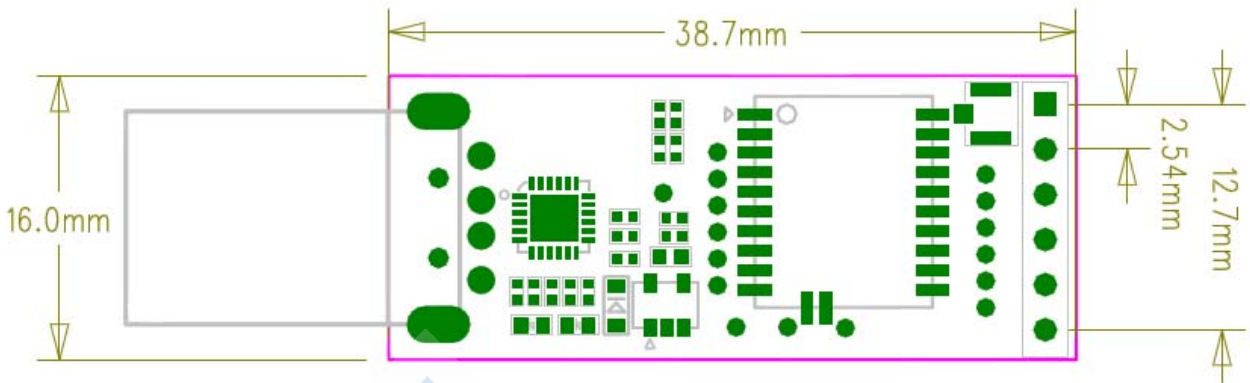

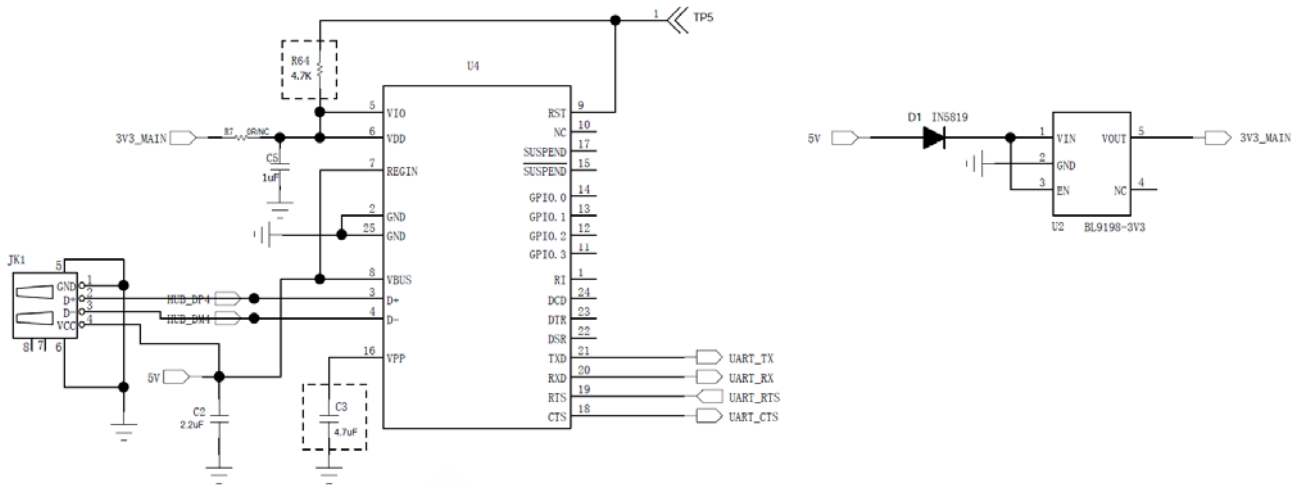

FSC-BT630 have Ceramic antenna , Add I-PEX:

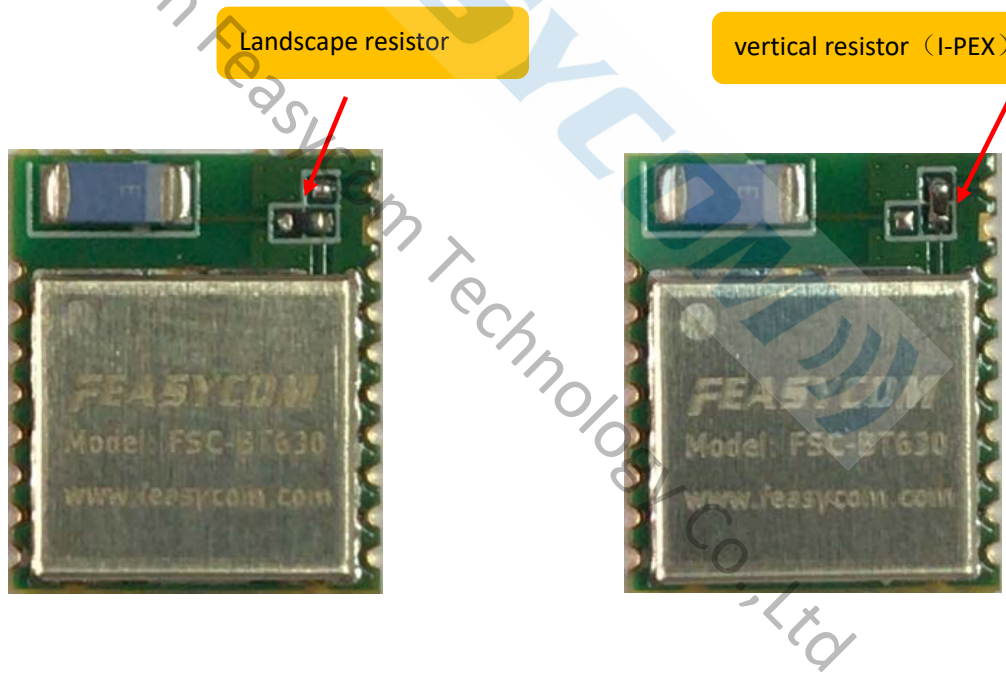

P1. Test Environment

1. Module & Upper Monitor Connecting Sketch (Using Serial Board for Demo)

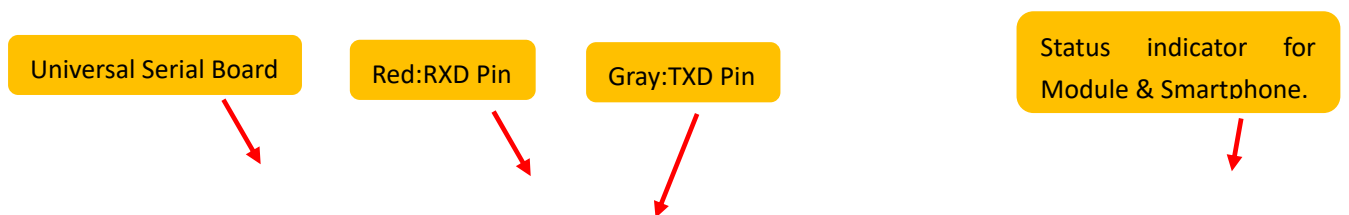

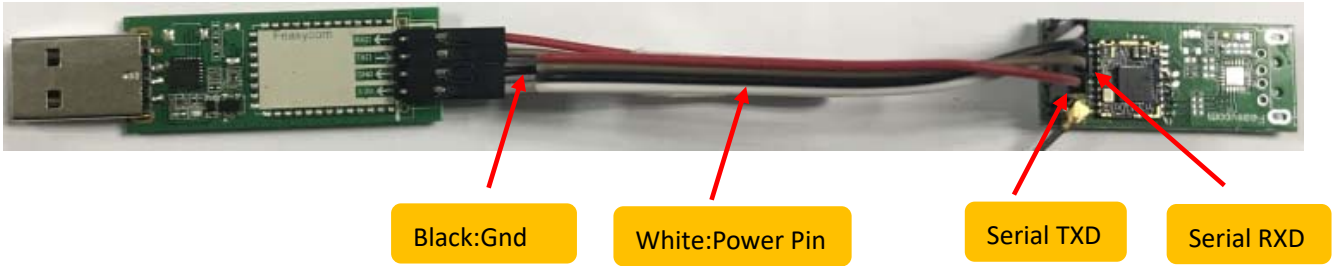

2. APP Download (Android & iOS)

1) Android APP  BTComm, please download from our www.feasycom.com or contact the sales man.

2) IOS APP  BLE Assistant, download from appstore or contact the sales man.

P2. Using Steps:

1, Connect to the computer's USB Port, LED Indicator : slow shinning, this means the module is under being search & connect status.(Take our FSC-BT611, as an example)



If module connect to the smart phone successfully, the LED Indicator is keeping lighting all the time



2, Open Feasycom Serial Port Tool Via PC, no need to install the software, setting as below showing.

Serial Port TX/RX Data Byte/Package: CRC32

1 Choose the right com no via device

2, Transfer

3, Serial Port Status Default Turn on

4, Click New

COM COM22 Baud 115200 Fluid None Close Save Clear

AT+NAME

Send

Hex Tx New line Timing 200 ms

File Send file Stop send

FEASYCOM | 飞易通

Instructions Customized

Feasycom	Name
	Version
	MAC
	Baud
	PIN
	Modify_name
	Modify_baud
	Modify_PIN

Developer option

About us

WeChat Official Account

Feasycom Technology Co.,LTD
www.feasycom.com

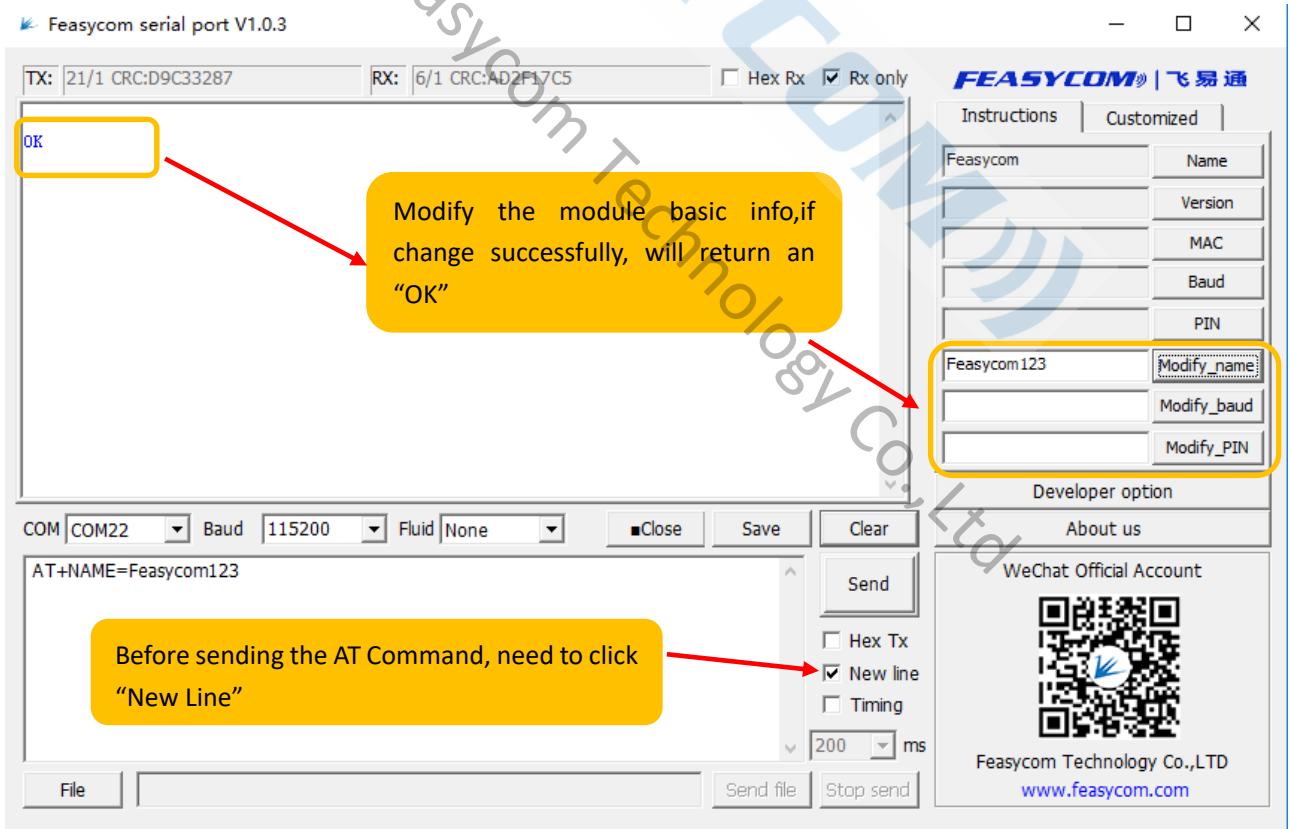
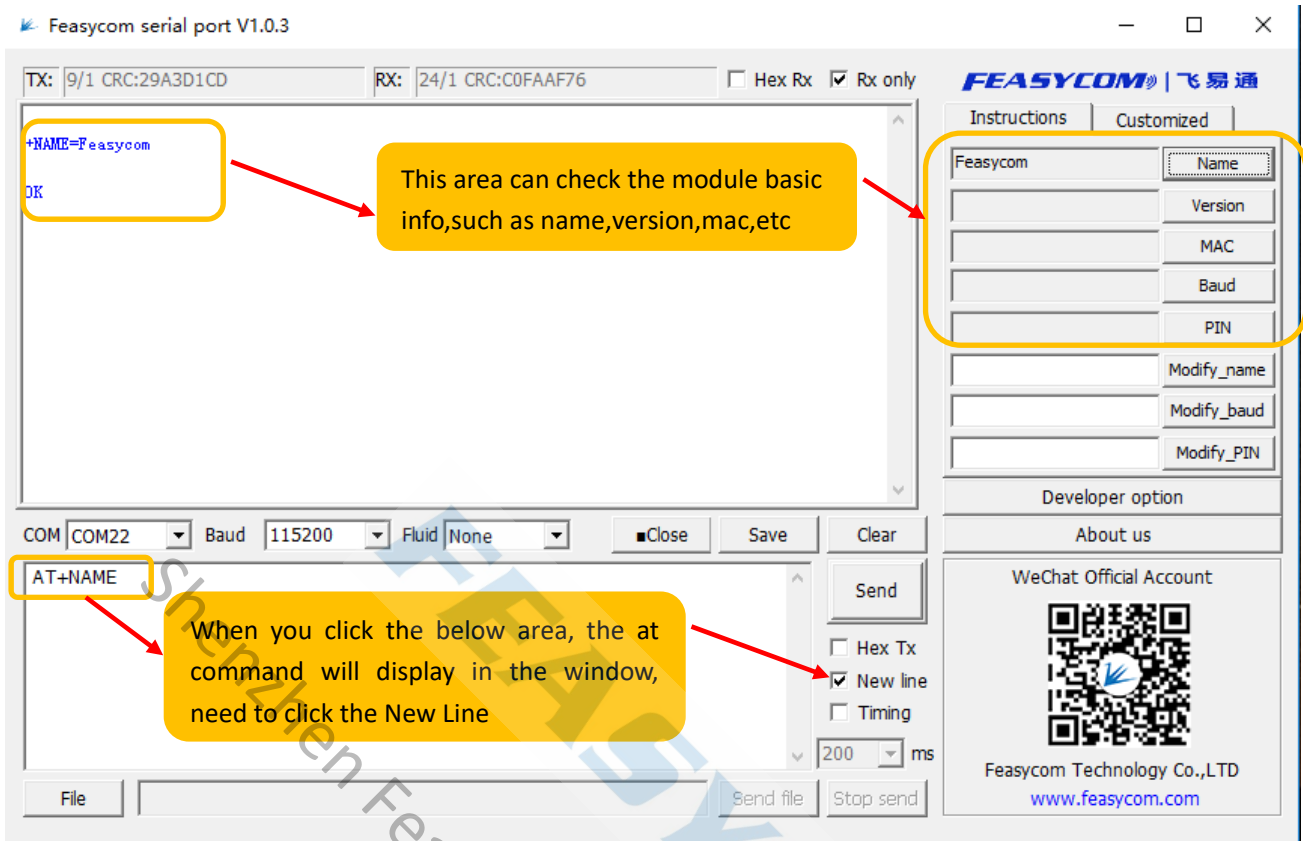

3, Smart Phone APP connect to the module, please follow the below steps (Turn on Bluetooth of Smart phone)

1) Android System : Open BTComm APP, search the target Bluetooth device, click auto-

connect,glide the interface can get the newest searching devices.

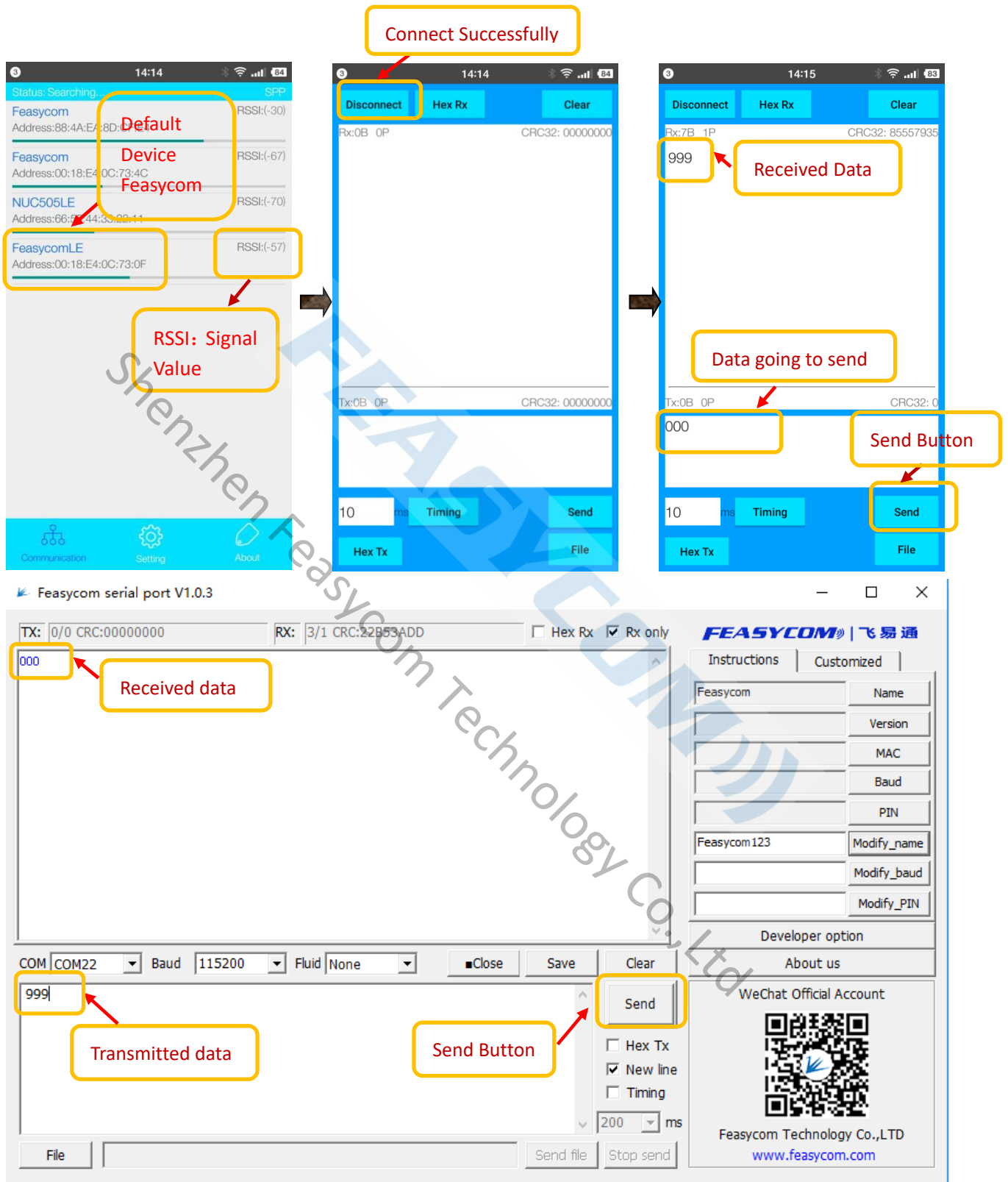

2) IOS System: Open BLE Assistant APP, search the target Bluetooth device,click auto-connect, glide the interface can get the newest searching devices.

Connected Successfully

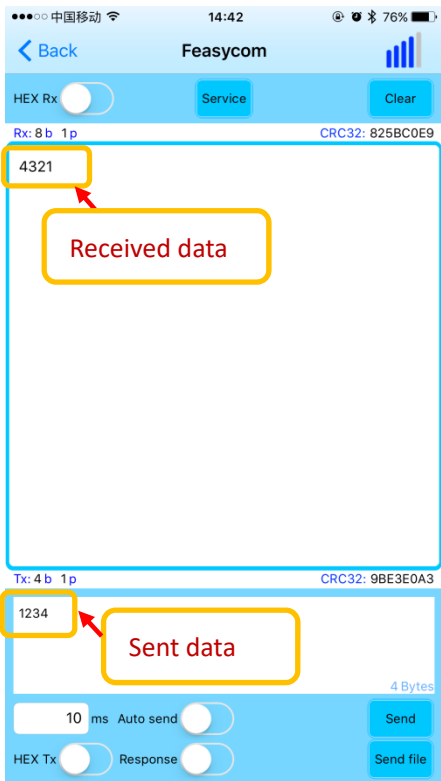
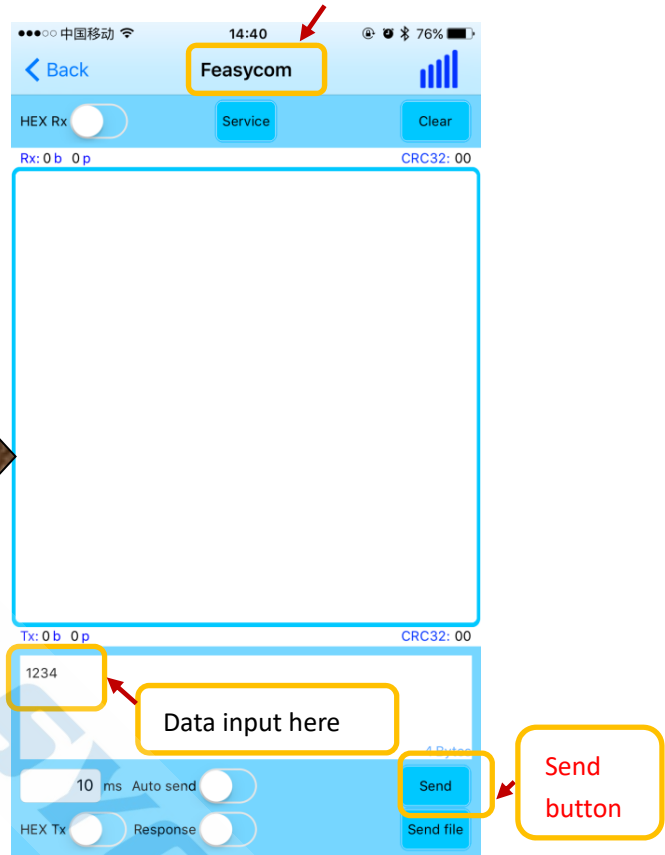
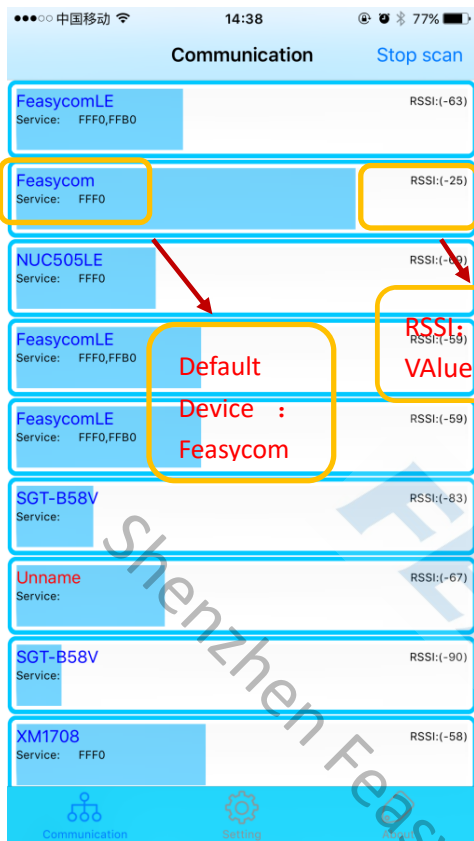



P3. FAQ

Q1: Power On Module, RX Command ,no feedback :

1> Check the indicator Light : Flash or not

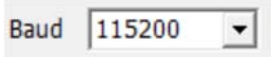
2>Make sure the COM NO : Correct or not

a)  Baud Rate Parameter: 115200

b)  Serial Port Close or Open

c) COM NO, whether is same as the device management of computer displaying

d) RXD Pin connect to Module TXD Pin, TXD Pin connect to Module RXD Pin.

e)  whether click this button.

Q2: Check the module whether under connection status

Remarks: If the module already connected to the smart phone, the module received AT command information will be sent to the smart phone as the common data information, will not execute the AT Command.

Q3: If already follow the steps as above showing, still can not identify the AT Command, better to make the module connect the smart phone APP, using the APP to send "12345" to the module, using the OSC to monitor the TXD of the module, whether there coming out the wave shape. Send the data to the module, using the OSC to monitor the RXD of the module, whether there coming out the wave shape, meanwhile, check the smart phone get the data or not.

Q4: Android Smart Phone why can not use the BLE:

1. Some old android smart phone not support BLE(We suggest to use our Bluetooth dual mode module)